

Indigo NXT Ice Machines

Installation, Operation and Maintenance Manual



Original Document

 **Caution**

Read this instruction before operating this equipment.

Safety Notices

Safety Notices

Read these precautions to prevent personal injury:

- Read this manual thoroughly before operating, installing or performing maintenance on the equipment. Failure to follow instructions in this manual can cause property damage, injury or death.
- Routine adjustments and maintenance procedures outlined in this manual are not covered by the warranty.
- Proper installation, care and maintenance are essential for maximum performance and trouble-free operation of your equipment. Visit our website www.manitowocice.com for manual updates, translations, or contact information for service agents in your area.
- This equipment contains high voltage electricity and refrigerant charge. Installation and repairs are to be performed by properly trained technicians aware of the dangers of dealing with high voltage electricity and refrigerant under pressure. The technician must also be certified in proper refrigerant handling and servicing procedures. All lockout and tag out procedures must be followed when working on this equipment.
- This equipment is intended for indoor use only. Do not install or operate this equipment in outdoor areas.

Definitions

DANGER

Indicates a hazardous situation that, if not avoided, will result in death or serious injury. This applies to the most extreme situations.

Warning

Indicates a hazardous situation that, if not avoided, could result in death or serious injury.

Caution

Indicates a hazardous situation that, if not avoided, could result in minor or moderate injury.

Notice

Indicates information considered important, but not hazard-related (e.g. messages relating to property damage).

NOTE: Indicates useful, extra information about the procedure you are performing.

▲Warning

Follow these precautions to prevent personal injury during installation of this equipment:

- Installation must comply with all applicable equipment fire and health codes with the authority having jurisdiction.
- To avoid instability the installation area must be capable of supporting the combined weight of the equipment and product. Additionally the equipment must be level side to side and front to back.
- Ice machines require a deflector when installed on an ice storage bin. Prior to using a non-OEM ice storage system with this ice machine, contact the bin manufacturer to assure their ice deflector is compatible.
- Prior to installing a non-OEM ice storage system with this ice machine, follow the manufacturers installation procedures and verify the location and installation meets the local/national mechanical codes and stability requirements.
- Remove all removable panels before lifting and installing and use appropriate safety equipment during installation and servicing. Two or more people are required to lift or move this appliance to prevent tipping and/or injury.
- Legs or casters must be installed and the legs/casters must be screwed in completely. When casters are installed the mass of this unit will allow it to move uncontrolled on an inclined surface. These units must be tethered/secured to comply with all applicable codes. Swivel casters must be mounted on the front and rigid casters must be mounted on the rear. Lock the front casters after installation is complete.
- Connect to a potable water supply only.
- Do not damage the refrigeration circuit when installing, maintaining or servicing the unit.
- This equipment contains refrigerant charge. Installation of the line sets must be performed by a properly trained and EPA certified refrigeration technician aware of the dangers of dealing with refrigerant charged equipment.
- Some 50 Hz models may contain up to 150 grams of R290 (propane) refrigerant. R290 (propane) is flammable in concentrations of air between approximately 2.1% and 9.5% by volume (LEL lower explosion limit and UEL upper explosion limit). An ignition source at a temperature higher than 470°C is needed for a combustion to occur. Refer to nameplate to identify the type of refrigerant in your equipment. Only trained and qualified personnel aware of the dangers are allowed to work on the equipment.

▲ Warning

Follow these electrical requirements during installation of this equipment.

- All field wiring must conform to all applicable codes of the authority having jurisdiction. It is the responsibility of the end user to provide the disconnect means to satisfy local codes. Refer to rating plate for proper voltage.
- This appliance must be grounded.
- This equipment must be positioned so that the plug is accessible unless other means for disconnection from the power supply (e.g., circuit breaker or disconnect switch) is provided.
- Check all wiring connections, including factory terminals, before operation. Connections can become loose during shipment and installation.

▲ DANGER

Do not operate equipment that has been misused, abused, neglected, damaged, or altered/modified from that of original manufactured specifications. This appliance is not intended for use by persons (including children) with reduced physical, sensory or mental capabilities, or lack of experience and knowledge, unless they have been given supervision concerning use of the appliance by a person responsible for their safety. Do not allow children to play with, clean or maintain this appliance without proper supervision.

▲ Warning

Follow these precautions to prevent personal injury while operating or maintaining this equipment:

- Read this manual thoroughly before operating, installing or performing maintenance on the equipment. Failure to follow instructions in this manual can cause property damage, injury or death.
- Crush/Pinch Hazard. Keep hands clear of moving components. Components can move without warning unless power is disconnected and all potential energy is removed.
- Moisture collecting on the floor will create a slippery surface. Clean up any water on the floor immediately to prevent a slip hazard.
- Objects placed or dropped in the bin can affect human health and safety. Locate and remove any objects immediately.
- Never use sharp objects or tools to remove ice or frost. Do not use mechanical devices or other means to accelerate the defrosting process.
- When using cleaning fluids or chemicals, rubber gloves and eye protection (and/or face shield) must be worn.

⚠ DANGER

Follow these precautions to prevent personal injury during use and maintenance of this equipment:

- It is the responsibility of the equipment owner to perform a Personal Protective Equipment Hazard Assessment to ensure adequate protection during maintenance procedures.
- Do Not Store Or Use Gasoline Or Other Flammable Vapors Or Liquids In The Vicinity Of This Or Any Other Appliance. Never use flammable oil soaked cloths or combustible cleaning solutions for cleaning.
- All covers and access panels must be in place and properly secured when operating this equipment.
- Risk of fire/shock. All minimum clearances must be maintained. Do not obstruct vents or openings.
- Failure to disconnect power at the main power supply disconnect could result in serious injury or death. The power switch DOES NOT disconnect all incoming power.
- All utility connections and fixtures must be maintained in accordance with the authority having jurisdiction.
- Turn off and lockout all utilities (gas, electric, water) according to approved practices during maintenance or servicing.
- Units with two power cords must be plugged into individual branch circuits. During movement, cleaning or repair it is necessary to unplug both power cords.
- Never use a high-pressure water jet for cleaning on the interior or exterior of this unit. Do not use power cleaning equipment, steel wool, scrapers or wire brushes on stainless steel or painted surfaces.
- Two or more people are required to move this equipment to prevent tipping.
- Locking the front casters after moving is the owner's and operator's responsibility. When casters are installed, the mass of this unit will allow it to move uncontrolled on an inclined surface. These units must be tethered/secured to comply with all applicable codes.
- The on-site supervisor is responsible for ensuring that operators are made aware of the inherent dangers of operating this equipment.
- Do not operate any appliance with a damaged cord or plug. All repairs must be performed by a qualified service company.

Table of Contents

Safety Notices

Safety Notices	3
----------------------	---

Section 1

General Information

Model Numbers	9
Accessories.....	9
How To Read A Model Number.....	10

Section 2

Installation

Installation	11
Location Requirements.....	11
Installation Requirements.....	11
Ice Machine Heat of Rejection	12
Air Baffle	14
Bin Installation Requirements.....	14
Bin Installation	15
Dispenser Installation	15
Electrical Requirements	16
Maximum Breaker Size & Minimum Circuit Amperage Chart....	17
Water Supply and Drain Line Sizing/Connections.....	20
Cooling Tower Applications (Water-Cooled Models)	21
Drain Connections	21
Remote Condenser and Condensing Unit Refrigeration System Installation	22
Calculating Installation Distances	23
Remote Condenser Models	24
QuietQube Models	25
Starting the Ice Machine.....	29
Remove Ice Thickness Probe Shipping Brackets.	29
Minimum/Maximum Slab Weight	29
Remote Ice Machine Usage with Non-Manitowoc Multi-Circuit Condensers.....	29

Table of Contents (continued)

Section 3 Operation

Touch Screen Features	31
Home Screen Icon Descriptions	32
Setup Wizard	33
Menu Screen Navigation.....	34
Ice Making Sequence of Operation	35
Control Board Timers.....	35
Minimum/Maximum Slab Weight.....	37
Ice Thickness Check	37

Section 4 Maintenance

Cleaning and Sanitizing.....	39
Cleaning/Sanitizing Procedure	40
Cleaning Procedure.....	40
Sanitizing Procedure	42
Parts Removal for Cleaning/Sanitizing	43
Preventative Maintenance Cleaning Procedure.....	44
Cleaning the Air Filter and Condenser	45
Removal from Service/Winterization	45

Section 5 Troubleshooting

Before Calling for Service Checklist	47
Service Faults	49

Section 1 General Information

Model Numbers

This manual covers the following models:

Self-Contained Air-Cooled	Self-Contained Water-Cooled	Remote Air-Cooled
IDF0300A IYF0300A	IDF0300W IYF0300W	----
IDT0420A IYT0420A	IDT0420W IYT0420W	----
IDT0450A IYT0450A	IDT0450W IYT0450W	----
IDT0500A IYT0500A IRT0500A	IDT0500W IYT0500W IRT0500W	IDT0500N IYT0500N ----
IDF0600A IYF0600A	IDF0600W IYF0600W	IDF0600N IYF0600N
IDT0620A IYT0620A IRT0620A IDP0620A	IDT0620W IYT0620W ----	----
IDF0900A IYF0900A IRF0900A	IDF0900W IYF0900W ----	IDF0900N IYF0900N ----
IDT1200A IYT1200A	IDT1200W IYT1200W	IDT1200N IYT1200N
IDT1500A IYT1500A	IDT1500W IYT1500W	IDT1500N IYT1500N
IDT1900A IYT1900A IRT1900A	IDT1900W IYT1900W ----	IDT1900N IYT1900N IRT1900N

QuietQube Indoor Head Section	QuietQube Air-Cooled Condensing Unit
IYF0600C IBF0620C	CVDF0600
IBF0820C IYF0900C	CVDF0900
IBT1020C IDT1200C IYT1200C	CVDT1200
IDF1400C IYF1400C	CVDF1400
IDF1800C IYF1800C	CVDF1800
IDF2100C IYF2100C	CVDF2100

Accessories

Ice Deflector

An ice deflector is required when the ice machine is installed on a bin. An ice deflector is not required when the ice machine is installed on a dispenser.

Bin Ice Level Accessory Kit

The bin level accessory connects to the circuit board and allows bin level adjustment of Indigo ice machines on B model bins. Installation instructions are included with the accessory. A bin level sensor is required to set a lower level of ice in the bin.

Top Air Discharge Kit

The top air discharge kit can be used on select ice machine models. This kit directs warm exhaust air upward rather than out the side panels.

AuCS® Automatic Cleaning System

This accessory reduces equipment cleaning expense. The AuCS® accessory monitors ice making cycles and initiates cleaning procedures automatically.

LuminIce® II

The LuminIce® growth inhibitor recirculates the air in the ice machine foodzone over a UV bulb. This process will inhibit the growth of common micro-organisms on all exposed foodzone surfaces.

How To Read A Model Number

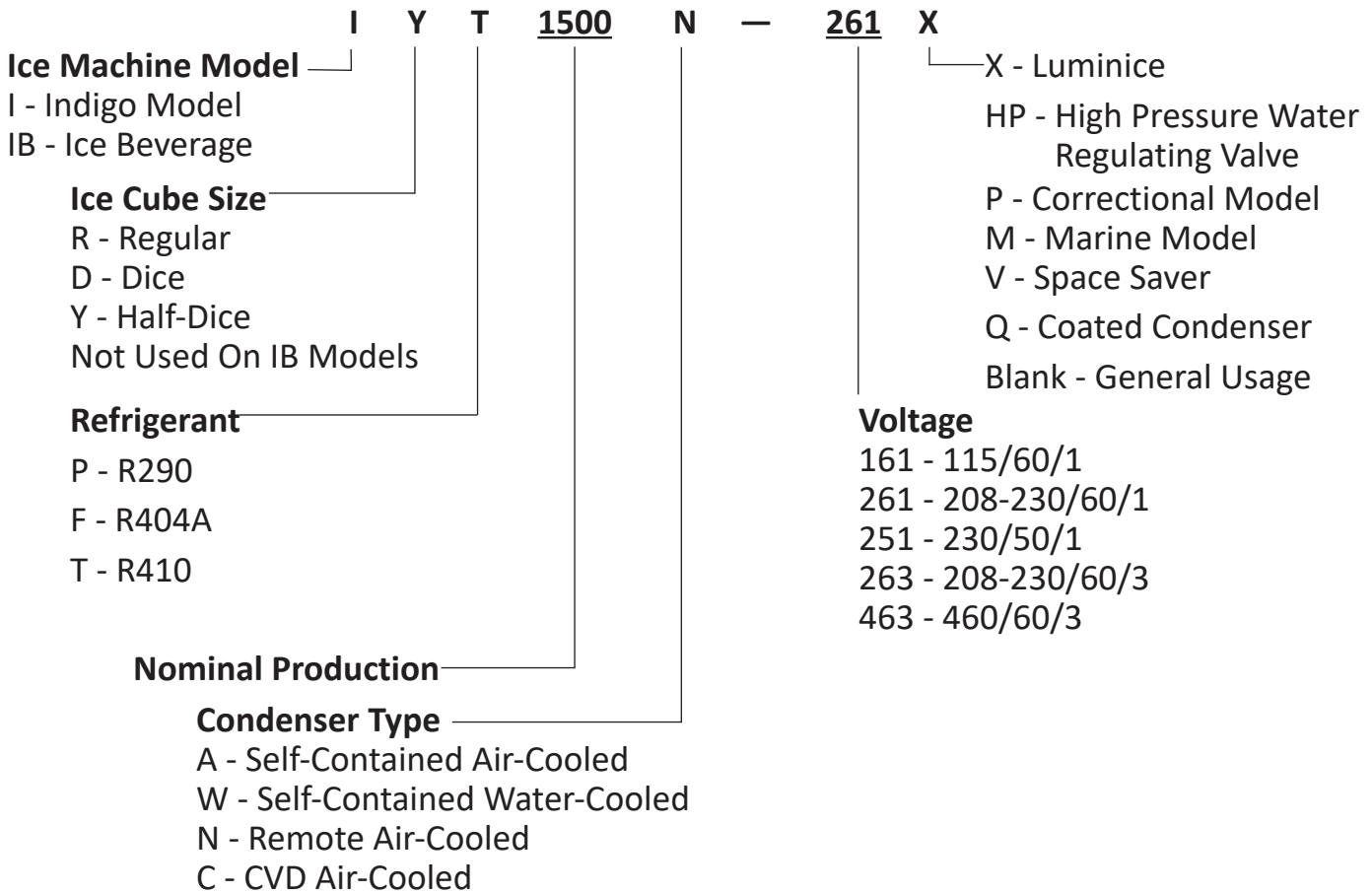

NOTE: These products are hermetically sealed and contain fluorinated greenhouse gas R404A or R410A.

Section 2 Installation

Installation

Location Requirements

The location selected for the ice machine head section must meet the following criteria. If any of these criteria are not met, select another location.

- The location must be indoors and must be free of airborne and other contaminants.
- The location must not be near heat-generating equipment or in direct sunlight.
- The location must allow enough clearance for water, drain, and electrical connections in the **rear of the ice machine**.
- The location must not obstruct airflow through or around the ice machine.

Installation Requirements

- The ice machine and bin must be level.
- Vent the ice machine and bin drains separately.
- Bin drain termination must have an air gap.
- The ice machine and bin must be sanitized after installation.
- The drain line must contain a union or other suitable means of disconnection at the ice machine.

QuietQube Models Only

- The ice machine top panel can be trimmed with an aviator snips to allow the line set, water line and electrical connections to exit the top. Only cut out what is needed, the back panel must support the top panel.
- The water inlet and electrical connection must contain a service loop to allow future access.

Minimum/Maximum Temperatures

Model	Minimum Air Temperature	Maximum Air Temperature
All Ice Machine Head Sections	35°F 2°C	110°F 43°C

All Remote Condensers	-20°F -29°C	120°F 49°C
-----------------------	----------------	---------------

QuietQube Condensing Units		
CVDF0600 CVDF0900 CVDT1200 CVDF2100	-20°F -29°C	120°F 49°C
CVDF1400 CVDF1800	-20°F -29°C	130°F 54°C

Ice Machine Heat of Rejection

Ice Machine Series	Heat of Rejection	
	Air Conditioning	Peak
IF0300	4600	5450
IT0420	*3800	*6000
IT0450	*5400	*6300
IT0500	*6100	*6900
IF0600	9000	13900
IT0620	*9000	*13900
IF0900	13000	16000
IT1200	*20700	*24500
IT1500	23000	27000
IT1900	26100	30500

* Data marked with an asterisk is preliminary and subject to change.

Use this information when:

- Sizing air conditioning equipment where self-contained air-cooled ice machines are installed.
- Determining the load on a cooling tower. Use the peak figure for sizing the load.

Clearance Requirements

I0300	Self-Contained Air-Cooled	Self-Contained Water-Cooled
Top/Sides	*16" (40 cm)	*8" (20 cm)
Back	*5" (13 cm)	*5" (13 cm)

IT0420 IT0450 IT0500 IT0620	Self-Contained Air-Cooled	Water-Cooled or Remote Condenser
Top/Sides	12" (31 cm)	8" (20 cm)
Back	5" (13 cm)	5" (13 cm)

IF0900	Self-Contained Air-Cooled	Self-Contained Water-Cooled
Top/Sides	*8" (20 cm)	*8" (20 cm)
Back	*5" (13 cm)	*5" (13 cm)

* Data marked with an asterisk is preliminary and subject to change - Model/serial plate information overrides all data listed in this chart.

IT1200	Self-Contained Air-Cooled	Water-Cooled or Remote Condenser
Top	*8" (20 cm)	*8" (20 cm)
Sides	*12" (31 cm)	*8" (20 cm)
Back	*5" (13 cm)	*5" (13 cm)

* Data marked with an asterisk is preliminary and subject to change - Model/serial plate information overrides all data listed in this chart.

IT1500	Self-Contained Air-Cooled	Water-Cooled or Remote Condenser
Top	12" (31 cm)	8" (20 cm)
Sides	8" (20 cm)	8" (20 cm)
Back	12" (31 cm)	5" (13 cm)

IT1900	Self-Contained Air-Cooled	Water-Cooled or Remote Condenser
Top/Sides	24" (61 cm)	8" (20 cm)
Back	12" (31 cm)	5" (13 cm)

NOTE: Top air discharge kits require the same clearance requirements as the comparable self-contained air-cooled model.

QuietQube Model Clearance Requirements

Model	Top	Back	Sides
IF0600C IF0900C IT1200C IF1400C IF1800C IF2100C	5" (13 cm)	5" (13 cm)	5" (13 cm)
IBF0620C IBF0820C IBF1020C	2"*** (5 cm)	5" (13 cm)	8" ** (20 cm)

** 61 cm (24") is recommended on top/sides for servicing

Condensing Unit Clearance Requirements

Model	Top/ Sides	Back	Front
CVDF0600 CVDF0900 CVDT1200 CVDF1400 CVDF1800 CVDF2100	0" (0 cm*)	48" (122 cm)	48" (122 cm)

* 61 cm (24") is recommended on top/sides for servicing

Notice

The ice machine must be protected if it will be subjected to temperatures below 32°F (0°C). Failure caused by exposure to freezing temperatures is not covered by the warranty.

Bin Installation Requirements

- The installation area must be capable of supporting the combined weight of the equipment and product.
- All ice machines installed on a bin require an ice deflector.
- Manitowoc bins have a deflector installed and require no modifications when used with a forward-facing evaporator.
- Ice machines with multiple evaporators require a deflector kit.
- Align sides and back of ice machine with sides and back of bin when placing ice machine on bin.
- Optional sales kits are available to adapt various sized or multiple ice machines on large bins.

Air Baffle

Self-Contained Air-cooled Only

The air-cooled baffle prevents condenser air from recirculating. To install:

1. Loosen the back panel screws next to the condenser.
2. Align the keyhole slots in the air baffle with the screw holes and slide the baffle down to lock in place.

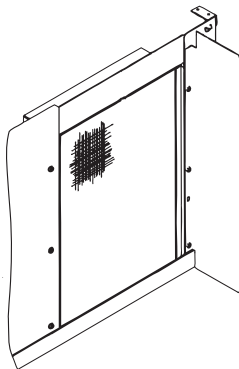

Bin Installation

NOTE: When using casters, the units must be tethered or secured to comply with all applicable codes. Swivel casters must be mounted on the front and rigid casters must be mounted on the rear. Lock the front casters after installation is complete.

1. Remove threaded plug from drain fitting.
2. Screw the leveling legs onto the bottom of the bin.
3. Screw the foot of each leg in as far as possible.
4. Move the bin into its final position.
5. Level the bin to assure that the bin door closes and seals properly. Use a level on top of the bin. Turn the base of each foot as necessary to level the bin.
6. Inspect bin gasket prior to ice machine installation. (Manitowoc bins come with a closed cell foam gasket installed along the top surface of the bin.)
7. Remove all panels from ice machine before lifting and installing on bin. Remove both front panels, top cover, left and right side panels.

Dispenser Installation

Observe following recommendations unless required by the dispenser manufacturer.

- An adapter is not required for ice machines that match the dispenser size.
- A deflector is not required.
- Ice level management is recommended to prevent water leakage or movement of ice machine during agitation.
- Align sides and back of ice machine with sides and back of dispenser when placing ice machine.
- Follow ice machine installation procedures in this manual and any additional installation requirements specified by the dispenser manufacturer.

Electrical Requirements

All electrical work, including wire routing and grounding, must conform to local, state and national electrical codes. The following precautions must be observed:

- The ice machine must be grounded.
- A separate fuse/circuit breaker (dedicated circuit) must be provided for each ice machine head section, condenser or condensing unit.
- A qualified electrician must determine proper wire size dependent upon location, materials used and length of run (minimum circuit ampacity can be used to help select the wire size).

⚠ Warning

All wiring must conform to local, state and national codes.

Voltage

The maximum allowable voltage variation is +10% / -5% of the rated voltage at ice machine start-up (when the electrical load is highest).

⚠ Warning

The ice machine must be grounded in accordance with national and local electrical codes.

Fuse/Circuit Breaker

A separate electrical disconnect, which disconnects all poles and has 3 mm (1/8") contact separation, must be provided for fixed wiring. Circuit breakers must be H.A.C.R. rated in USA.

Minimum Circuit Ampacity

The minimum circuit ampacity is used to help select the wire size of the electrical supply. (Minimum circuit ampacity is not the ice machine's running amp load.)

The wire size (or gauge) also depends on location, materials used, length of run, etc., so it must be determined by a qualified electrician.

Ground Fault Circuit Interrupter

We do not recommend the use of a GFCI/GFI circuit protection with our equipment. If a GFCI/GFI is required by code, use a GFCI/GFI breaker rather than an outlet, which is more prone to intermittent nuisance trips than panel circuit breakers.

Maximum Breaker Size & Minimum Circuit Amperage Chart

NOTE: Due to continuous product improvements, this information is for reference only. Please refer to the ice machine data plate to verify electrical data. Data plate information overrides information listed on this page.

Ice Machine	Voltage/ Phase/Cycle	Air-Cooled		Water-Cooled		Remote Condenser	
		Maximum Fuse/ Circuit Breaker	Minimum Circuit Amps	Maximum Fuse/ Circuit Breaker	Minimum Circuit Amps	Maximum Fuse/ Circuit Breaker	Minimum Circuit Amps
IF0300	115/1/60	15	*10.8	15	*10.0	---	---
	230/1/50	15	*6.1	15	*5.6	---	---
	230/1/60	15	*6.1	15	*5.7	---	---
IT0420	115/1/60	15	11.3	15	10.6	---	---
	208-230/ 1/60	15	5.5	15	5.2	---	---
	230/1/50	15	5.7	---	---	---	---
IT0450	115/1/60	20	11.9	20	11.2	---	---
	208-230/ 1/60	15	5.6	15	5.3	---	---
	230/1/50	15	5.6	15	5.3	---	---
IT0500	115/1/60	15	11.5	15	10.8	20	13.7
	208-230/ 1/60	15	5.1	15	4.8	---	---
	230/1/50	15	5.6	---	---	---	---
IF0600	208-230/ 1/60	15	*11.1	15	*10.7	15	*11.7
	230/1/50	15	*6.7	15	*6.1	15	*7.1
IT0620	115/1/60	20	12.2	20	11.6	---	---
	208-230/ 1/60	15	5.9	15	5.6	---	---
	230/1/50	15	5.6	15	5.4	---	---
IF0900	208-230/ 1/60	20	*12.2	20	*11.2	20	*12.2
	208-230/ 3/60	15	*9.7	15	*8.7	15	*9.7
	230/1/50	20	*12.2	20	*11.2	15	*12.2

Ice Machine	Voltage/ Phase/Cycle	Air-Cooled		Water-Cooled		Remote Condenser	
		Maximum Fuse/ Circuit Breaker	Minimum Circuit Amps	Maximum Fuse/ Circuit Breaker	Minimum Circuit Amps	Maximum Fuse/ Circuit Breaker	Minimum Circuit Amps
IT1200	208-230/ 1/60	20	14.2	20	13.4	15	11.0
	208-230/ 3/60	15	8.6	15	7.9	15	9.2
	230/1/50	20	14.0	20	13.3	15	11.1
IT1500	208-230/ 1/60	25	15.4	25	14.0	25	14.0
	208-230/ 3/60	20	12.8	20	11.3	20	11.3
	230/1/50	25	14.9	25	14.2	25	15.2
	380-460/ 3/50-60	---	---	15	*6.4	---	---
IT1900	208-230/ 1/60	30	17.9	25	16.5	25	17.0
	208-230/ 3/60	20	14.2	20	12.8	20	13.0
	230/1/50	25	15.8	25	15.0	25	15.3
	380-460/ 3/50-60	---	---	15	*6.5	---	---

* Data marked with an asterisk is preliminary and subject to change - Model/serial plate information overrides all data listed in this chart.

QuietQube Head Sections

Ice Machine	Voltage/Phase/ Cycle	Maximum Fuse/ Circuit Breaker	Minimum Circuit Amps	Total Amps
Ice Beverage Models	115/1/60	15 amp	---	1.2
	230/1/50	15 amp	---	1.2
All Non IB QuietQube Models	115/1/60	15 amp	1.2	---
	230/1/50	15 amp	1.2	---

CVD Condensing Units

Condensing Unit	Voltage/Phase/ Cycle	Maximum Fuse/Circuit Breaker	Minimum Circuit Amps	Minimum Wire Size Required by Manitowoc
CVDF0600	208-230/1/60	15 amp	*11.6	#12 Solid Copper Conductor
	208-230/3/60	15 amp	*10.2	#12 Solid Copper Conductor
	230/1/50	15 amp	*10.2	#12 Solid Copper Conductor
CVDF0900	208-230/1/60	20 amp	*12.5	#10 Solid Copper Conductor
	208-230/3/60	15 amp	*9.5	#12 Solid Copper Conductor
	230/1/50	20 amp	*12.5	#10 Solid Copper Conductor
CVDT1200	208-230/1/60	25 amp	14.8	#10 Solid Copper Conductor
	208-230/3/60	15 amp	9.3	#12 Solid Copper Conductor
CVDF1400	208-230/1/60	20 amp	*11.7	#10 Solid Copper Conductor
	208-230/3/60	15 amp	*8.9	#12 Solid Copper Conductor
CVDF1800	208-230/1/60	40 amp	*25.0	#8 Solid Copper Conductor
	208-230/3/60	25 amp	*20.0	#10 Solid Copper Conductor
	230/1/50	40 amp	*25.0	#8 Solid Copper Conductor
CVDF2100	208-230/1/60	50 amp	*40.0	#6 Solid Copper Conductor
	208-230/3/60	30 amp	*30.0	#10 Solid Copper Conductor

* Data marked with an asterisk is preliminary and subject to change - Model/serial plate information overrides all data listed in this chart.

Water Supply and Drain Line Sizing/Connections				
⚠ Caution				
Do not apply heat to water inlet valve or water drain fittings. Heating will damage the nonmetallic connector. Do not over tighten fittings. Two turns after hand tight is the maximum.				
<ul style="list-style-type: none"> Local water conditions may require treatment of the water to inhibit scale formation, filter sediment, and remove chlorine odor and taste. Connect ice making water inlet to potable water only. Do not connect to hot water supply. Install a water shut-off valve. Insulate water and drain lines to prevent condensation. 				
Location	Water Temperature	Water Pressure	Ice Machine Fitting	Tubing Size up to Ice Machine Fitting
Ice Making Water Inlet	40°F (4.4°C) Min. 90°F (32°C) Max.	20 psi (140 kPa) Min. 80 psi (550 kPa) Max.	3/8" Female Pipe Thread	3/8" (10 mm) minimum inside diameter
Ice Making Water Drain	—	—	1/2" Female Pipe Thread	1/2" (13 mm) minimum inside diameter
Condenser Water Inlet	40°F (4.4°C) Min. 90°F (32°C) Max.	20 psi (140 kPa) Min. 150 psi (1030 kPa) Max.	I0300 - I1000 = 3/8" Female Pipe Thread I1200 - I1800 = 1/2" Female Pipe Thread	
Condenser Water Drain	—	—	1/2" Female Pipe Thread	1/2" (13 mm) minimum inside diameter
Bin Drain	—	—	3/4" Female Pipe Thread	3/4" (19 mm) minimum inside diameter
Large Capacity Bin Drain			1" Female Pipe Thread	1" (25 mm) minimum inside diameter

Min. = Minimum, Max. = Maximum

Air Gap

A greater than 1-inch air gap is built into the ice machine for back-flow prevention. This air gap exceeds NSF 12 requirements for back-flow prevention.

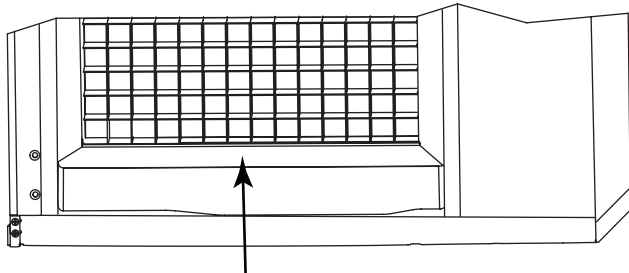

This air gap is greater than 1"

Cooling Tower Applications (Water-Cooled Models)

A water cooling tower installation does not require modification of the ice machine.

- Water pressure at the condenser cannot exceed 150 psig (1034 kPa). A special order unit is available that allows water pressure up to 350 psig (2413 kPa).
- Water entering the condenser must not exceed 90°F (32°C).
- Water flow through the condenser must not exceed 5 gallons (19 liters) per minute.
- Allow for a pressure drop of 7 psi (50 kPa) between the condenser water inlet and the outlet of the ice machine.
- Water exiting the condenser must not exceed 110°F (43°C).

Drain Connections

Follow these guidelines when installing drain lines to prevent drain water from flowing back into the ice machine and storage bin:

- Drain lines must have a of run 1.5 inch drop per 5 feet (2.5 cm per meter) and must not create traps.
- The floor drain must be large enough to accommodate drainage from all drains.
- Run separate bin and ice machine drain lines. Insulate them to prevent condensation.
- Vent the ice machine drain to the atmosphere.
- Drain termination must have an air gap that meets local code.

Auxiliary Base Drain Installation

An auxiliary drain is located in the ice machine base to remove moisture in high humidity areas.

1. View the back of the ice machine base on the compressor side and locate and remove the cap plug.
2. Route tubing to an open site drain:
 - Use 1/2 inch CPVC tubing.
 - Apply a bead of silicone around the exterior of the ice machine tubing and insert into ice machine base. The silicone will secure the tubing and provide a watertight seal.
 - Provide support for tubing.

Remote Condenser and Condensing Unit Refrigeration System Installation			
Each ice machine head section ships from the factory with a refrigerant charge appropriate for the entire system operation. The serial tag on the ice machine indicates the refrigerant charge.			
QuietQube® Ice Machine	Remote Condenser	Line Set*	Additional Refrigerant Charge for 50' to 100' (15 to 30 Meter) Line Sets
IF0600C IBF0620C	CVDF0600	RC-21 RC-31 RC-51	1.5 lbs - 680 g
IBF0820C IF0900C	CVDF0900		2 lbs - 907 g
IBT1020C	CVDT1200		2 lbs - 907 g
IT1200C	CVDT1200		2 lbs - 907 g
IF1400C	CVDF1400		RC-20
IF1800C	CVDF1800	RC-30 RC-50	2 lbs - 907 g
IF2100C	CVDF2100	RC-23 RC-33 RC-53	4 lbs - 1814 g

*Line Set	Suction Line	Liquid Line	Minimum Insulation Thickness
RC 21/31/51	5/8 inch 16 mm	3/8 inch 10 mm	1/2" (13 mm) Suction Line 1/4" (7 mm) Liquid Line
RC 20/30/50	3/4 inch 19 mm	1/2 inch 13 mm	1/2" (13 mm) Suction Line 1/4" (7 mm) Liquid Line
RC 23/33/53	3/4 inch 19 mm	5/8 inch 16 mm	1/2" (13 mm) Suction Line 1/4" (7 mm) Liquid Line

▲Warning
 Installation of a QuietQube® Condensing Unit may require the use of special equipment for placement. Trained and qualified personnel are required for proper rigging and lifting. Holes are provided on the corners of the condensing unit to allow the use of lifting shackles.

Important
 Manitowoc remote systems are only approved and warranted as a complete new package. Warranty on the refrigeration system will be void if a new ice machine head section is connected to pre-existing (used) tubing or condensing units or vice versa.

Remote Condenser Models

Ice Machine	Remote Condenser	Additional Amount of Refrigerant to Be Added to Nameplate Charge for 50' to 100' (15 to 30 Meter) Line Sets
IT0500N	JCT0500	1.5 lbs - 680 g
IF0600N	JCT0900	1.5 lbs - 680 g
IF0900N	JCT0900	2 lbs - 907 g
IT1200N	JCT1200	2 lbs - 907 g
IT1500N	JCT1500	2 lbs - 907 g
IT1900N	JCT1500	2 lbs - 907 g

Line Set	Discharge Line	Liquid Line	Model
RT 20/35/50 R404A	1/2 inch 13 mm	5/16 inch 7.9 mm	iF0600N iF0900N
RT 20/35/50 R410A	1/2 inch 13 mm	5/16 inch 7.9 mm	iT0500N iT1200N
RL 20/35/50 R410A	1/2 inch 13 mm	3/8 inch 9.5 mm	iT1500N iT1900N

NOTE: R404A line sets have white protective caps and R410A line sets have pink protective caps.

⚠ Warning

Potential Personal Injury Situation

The ice machine head section contains the refrigerant charge. Installation and brazing of the line sets must be performed by a properly trained and EPA certified refrigeration technician aware of the dangers of dealing with refrigerant charged equipment.

CALCULATING INSTALLATION DISTANCES

Line Set Length

The maximum tubing length is 100 feet (30 meters).

Line Set Rise/Drop

The maximum rise is 35 feet (10.7 meters).

The maximum drop is 15 feet (4.5 meters).

Notice

If a line set has a rise followed by a drop, another rise cannot be made. Likewise, if a line set has a drop followed by a rise, another drop cannot be made.

Calculated Line Set Distance

The maximum calculated distance is 150 feet (45 meters).

Line set rises, drops, horizontal runs (or combinations of these) in excess of the stated maximums will exceed compressor start-up and design limits. This will cause poor oil return to the compressor. Make the following calculations to make sure the line set layout is within specifications.

1. Insert the **measured rise** into the formula below. Multiply by 1.7 to get the **calculated rise**.
2. Insert the **measured drop** into the formula below. Multiply by 6.6 to get the **calculated drop**.
3. Insert the **measured horizontal distance** into the formula below. No calculation is necessary.

- 4. Add together the **calculated rise**, **calculated drop**, and **horizontal distance** to get the **total calculated distance**. If this total exceeds 150 feet (45 meters), move the condenser/condensing unit to a new location and perform the calculations again.

Maximum Line Set Distance Formula

Step 1.

Measured Rise (R) 35 feet (10.7 meters)

$$\text{Maximum } \underline{\hspace{2cm}} \times 1.7 = \underline{\hspace{2cm}} \text{ Calculated Rise}$$

Step 2.

Measured Drop (D) 15 feet (4.5 meters)

$$\text{Maximum } \underline{\hspace{2cm}} \times 6.6 = \underline{\hspace{2cm}} \text{ Calculated Drop}$$

Step 3.

Measured Horizontal Distance (H) 100 feet (30 meters) Maximum

$$\underline{\hspace{2cm}} \text{ Horizontal Distance}$$

Step 4.

Total Calculated Distance 150 feet (45 meters) Maximum

$$\underline{\hspace{2cm}} \text{ Total Calculated Distance}$$

Notice

The refrigeration system warranty will not apply if the Manitowoc Ice Machine and Manitowoc CVD Condensing Unit are not installed according to specifications. This warranty also will not apply if the refrigeration system is modified with a condenser, heat reclaim device, or other parts or assemblies not approved by Manitowoc.

REMOTE CONDENSER MODELS

Step 1 Secure the Condenser.

Through-holes are provided to secure the condenser to a curb, rack or wooden timber.

▲Warning

The ice machine head section contains refrigerant charge. The ice machine head section contains refrigeration valves that must remain closed until proper installation of the line sets is completed.

▲Warning

Electrical power to the ice machine head section, condensing unit or condenser must be disconnected before proceeding.

Step 2 Route the Refrigeration Tubing.

Route the refrigeration tubing between the ice machine head section and the condenser.

- Maximum line set exposed on rooftop is 25% of total line set length.
- A qualified person must perform all roof penetrations.

Step 3 Connect the Line Set.

In most cases, by routing the line set properly, shortening will not be necessary. When shortening or lengthening is required, do so before connecting the line set to the ice machine or the remote condenser. This prevents the loss of refrigerant in the ice machine or condenser.

The quick connect fittings on the line sets are equipped with access valves. Use these valves to recover any vapor charge from the line set.

When lengthening or shortening lines, follow good refrigeration practices, purge with nitrogen and insulate all tubing. Do not change the tube sizes. Evacuate the lines and place about 5 oz (145 grams) of vapor refrigerant charge in each line.

1. Remove the dust caps from the line set, condenser and ice machine.
2. Apply refrigeration oil to the threads on the quick-disconnect couplers before connecting them to the condenser.
3. Carefully thread the female fitting to the condenser or ice machine by hand, then tighten the couplings with a wrench until they bottom out.
4. Turn an additional quarter turn to ensure proper brass-to-brass seating. Torque to the following specifications:

Liquid Line	Discharge Line
10 - 12 ft lbs 13.5-16.2 N•m	35 - 45 ft lbs 47.5-61.0 N•m

5. Check all fittings and valve caps for leaks and reinstall and tighten caps.
6. The receiver service valve is closed during shipment and must be opened before starting the ice machine.
 - A. Remove the receiver service valve cap.
 - B. Backseat (open) the valve.
 - C. Reinstall the cap and panels.

Installation is finished for remote condenser models. Proceed to page 29 for start-up procedure.

QUIETQUBE MODELS

Step 1 Secure the Condensing Unit.

Through-holes are provided to secure the condensing unit to a curb, rack or wooden timber.

Step 2 Route the Refrigeration Tubing.

Route the refrigeration tubing between the ice machine head section and the condenser or CVD condensing unit.

- A suction line oil trap is required when rise is more than 20 feet (6 meters).
- Only one trap is allowed in the line set.
- Shorten the line set as required, do not coil line set.

Manitowoc S-Trap Kit

Model	S-Trap Kit Number	Tubing Size
IBF0620C IBF0820C IBT1020C IF0600C IF0900C IT1200C	K00172	5/8 inch (16 mm)
IF1400C IF1800C IF2100C	K00166	3/4 inch (19 mm)

- Maximum amount of time the refrigeration system can be exposed to the atmosphere is 15 minutes.
- Purge line set with dry nitrogen while brazing.
- Shutoff valves for the line set on the ice machine must remain closed and be protected from heat during brazing.
- The condensing unit ships with a 50/50 mixture of nitrogen/helium.

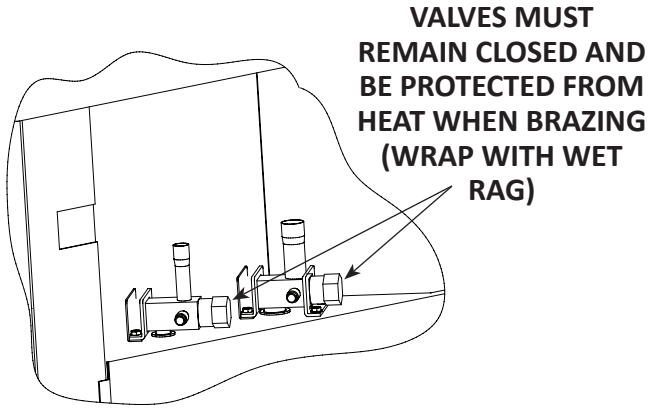

Step 3 Pressure Test and Evacuate Line Set and CVD Condensing Unit.

- Shutoff valves for the line set must remain closed until pressure testing and evacuation are complete.
- Valve core removal tools that allow for removal and installation of the valve cores without removing hoses for the manifold gauge set are recommended to decrease the evacuation time.
- Pressure test at 150 psi (1000 kPa) for a minimum of 15 minutes.
- Minimum evacuation level is 500 microns.

Pressure test the line sets and CVD Condensing Unit with 150 psi (1000 kPa) of dry nitrogen. Add nitrogen at the shutoff valves for the line set located at the back of the ice machine head section or from the access valves located in the CVD Condensing Unit. Complete the pressure test, verify no leaks are present and remove the nitrogen from the system before connecting the vacuum pump. Connect vacuum pump and evacuate system to 500 microns.

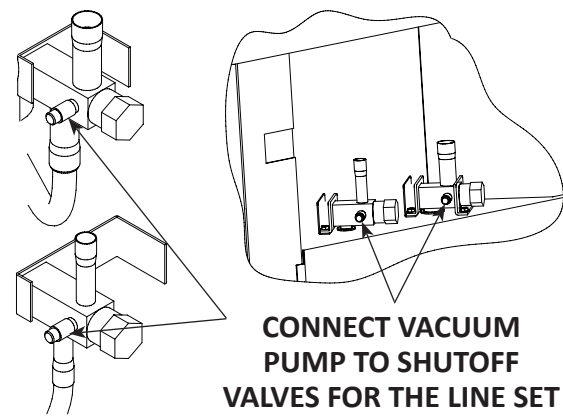
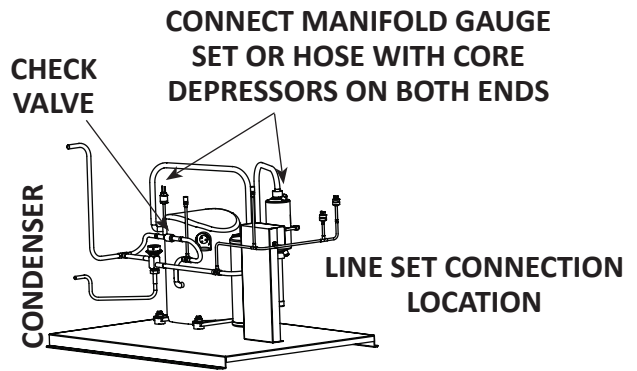
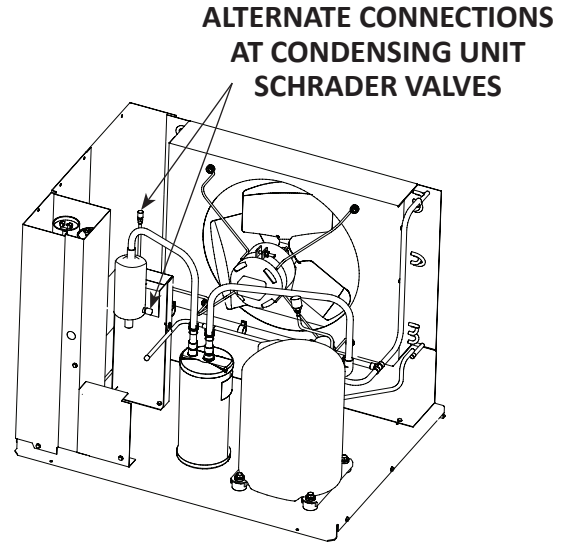

Step 4 Open Valves for the Line Set and Receiver.

You will not hear refrigerant flow when the valves are opened. Refrigerant will not flow until the ice machine is started and the solenoid valve opens.

- All valve caps must be reinstalled, tightened and leak-checked to assure no refrigerant leakage exists.
- Counterclockwise opens all valves:
 - A. Open the shutoff valves for the suction and liquid lines.
 - B. Open the receiver service valve until back seated (when used).

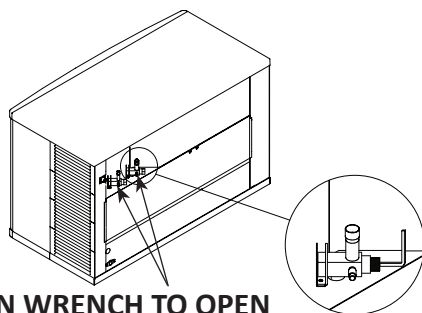

USE ALLEN WRENCH TO OPEN (TURN COUNTERCLOCKWISE) SHUTOFF VALVES FOR THE LIQUID AND SUCTION LINES

QuietQube Models

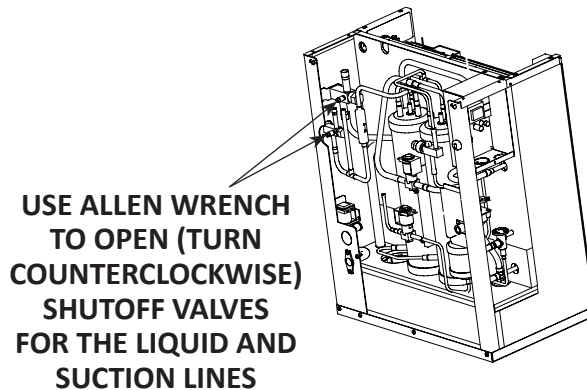

USE ALLEN WRENCH TO OPEN (TURN COUNTERCLOCKWISE) SHUTOFF VALVES FOR THE LIQUID AND SUCTION LINES

Ice Beverage Models

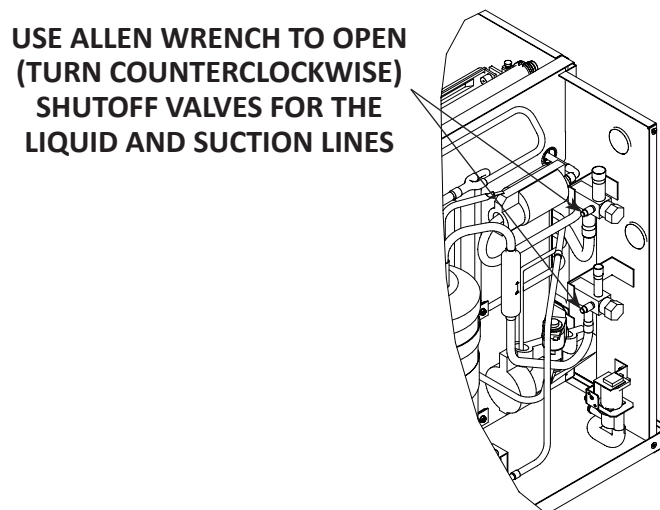

USE ALLEN WRENCH TO OPEN (TURN COUNTERCLOCKWISE) SHUTOFF VALVES FOR THE LIQUID AND SUCTION LINES

IF1400C/IF1800C/IF2100C

Notice

After opening suction, discharge and receiver service valves, refrigerant pressure will not be detected until the ice machine starts a freeze cycle and the solenoid valves energize.

Step 5 Leak-Check the Refrigeration System.

- A. Connect power to the ice machine head section - Do not connect power to the CVD condensing unit.
- B. Press the power switch and energize the ice machine for 60 seconds to equalize pressures.
- C. Disconnect power to the ice machine head section.
- D. Leak-check line set connections, S trap and all factory joints in head section and condensing unit.
- E. Connect power to the CVD condensing unit and allow system to pump down.

Step 6 Insulation Requirements

- To prevent condensation, the entire suction line, including the shutoff valve, must be insulated.
- All insulation must be airtight and sealed at both ends.

The following insulation requirements prevent condensation at 90° F (32°C) ambient temperature and 90% relative humidity. If higher humidity is expected, increase insulation thickness:

Suction Line	Liquid Line	Min. Insulation Thickness
3/4 inch 19 mm	1/2 inch 13 mm	Suction Line - 1/2" (13 mm)
5/8 inch 16 mm	3/8 inch 10 mm	Liquid Line - 1/4" (7 mm)
3/4 inch 19 mm	5/8 inch 16 mm	Suction Line - 3/4" (19 mm) Liquid Line - 1/4" (7 mm)

Step 7 Insulation for the Suction Shutoff Valve

The insulation for the suction shutoff valve is located in the plastic bag taped to the water curtain.

Step 8 Ice Beverage Models Only

The thermostat probe must be moved from the shipping position to the ice-making position.

- The bin thermostat probe must be rotated down to enable ice contact and proper operation.
 - Verify probe wire does not interfere with the water curtain.
 - The control is preset and does not require programming.
1. Loosen thumbscrew securing probe.
 2. Rotate the probe from horizontal to vertical position.
 3. Tighten thumbscrew to secure probe.

Starting the Ice Machine

Starting the ice machine and completing the Operational Checks are the responsibilities of the owner/operator.

Adjustments and maintenance procedures outlined in this manual are not covered by the warranty.

REMOVE ICE THICKNESS PROBE SHIPPING BRACKETS.

Remove and discard shipping brackets before starting the ice machine.

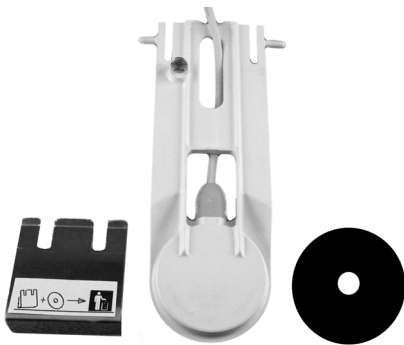

Step 1 Ice machine must be programmed refer to “Touch Screen Features” on page 31 for details.

Step 2 Refer to “Cleaning/Sanitizing Procedure” on page 40 and sanitize the ice machine and bin before placing in operation.

Step 3 Refer to “Ice Making Sequence of Operation” on page 35 for operational details.

MINIMUM/MAXIMUM SLAB WEIGHT

Adjust ice thickness to maintain the correct bridge thickness and “Minimum/Maximum Slab Weight” on page 37.

Remote Ice Machine Usage with Non-Manitowoc Multi-Circuit Condensers

Warranty

The sixty (60) month compressor warranty, including thirty six (36) month labor replacement warranty, shall not apply when the remote ice machine is not installed within the remote specifications. The foregoing warranty shall not apply to any ice machine installed and/or maintained inconsistent with the technical instructions provided by Manitowoc Ice. Performance may vary from Sales specifications. ARI certified standard ratings only apply when used with a Manitowoc remote condenser.

If the design of the condenser meets the specifications, Manitowoc’s only approval is for full warranty coverage to be extended to the Manitowoc manufactured part of the system. Since Manitowoc does not test the condenser in conjunction with the ice machine, Manitowoc will not endorse, recommend, or approve the condenser, and will not be responsible for its performance or reliability.

Important

Manitowoc warrants only complete new and unused remote packages. Guaranteeing the integrity of a new ice machine under the terms of our warranty prohibits the use of pre-existing (used) tubing or condensers.

Design & Burst Pressure

Design Pressure 600 psig - 4137 kPa

Burst Pressure 2500 psig - 17237 kPa

Head Pressure Control Valve

Do not use a fan cycling control to try to maintain discharge pressure. Compressor failure will result. Any remote condenser connected to a Manitowoc Ice Machine must have the OEM head pressure control valve installed. Manitowoc will not accept substitute “off the shelf” head pressure control valves.

Fan Motor

The condenser fan must be on during the complete ice machine freeze cycle (do not cycle on fan cycle control). The ice maker has a condenser fan motor circuit for use with a Manitowoc condenser. It is recommended that this circuit be used to control the condenser fan(s) on the multi-circuit condenser to assure it is on at the proper time. Do not exceed the rated amps for the fan motor circuit listed on the ice machine’s serial tag.

Internal Condenser Volume

The multi-circuit condenser internal volume must not be less than or exceed that used by Manitowoc. Do not exceed internal volume and try to add charge to compensate, as compressor failure will result.

Model	Minimum	Maximum
IT0500N	0.020	0.030
IF0600N/IF0900N IT1200N	0.045	0.060
IT1500N/IT1900N	0.085	0.105

Heat of Rejection

Model	Peak	Average
IT0500N	6100	6900
IF0600N	9000	13900
IF0900N	13000	1600
IT1200N	20700	24500
IT1500N	23000	27000
IT1900N	26100	30500

Refrigerant Charge

The ice machine model/serial tag lists the refrigerant amount. Remote condensers and line sets contain a vapor charge only.

Model	Amount	Type
IT0500N	6.0 lbs - 2.72 kg	R410A
IF0600N	*6.5 lbs - 2.95 kg	R404A
IF0900N	*7 lbs - 3.18 kg	R404A
IT1200N	7.5 lbs - 3.40 kg	R410A
IT1500N	8.0 lbs - 3.63 kg	R410A
IT1900N	8.0 lbs - 3.63 kg	R410A

*Data marked with an asterisk is preliminary and subject to change - Model/serial plate information overrides all data listed in this chart.

Quick Connect Fittings

The ice machine and line sets come with quick connect fittings. It is recommended that matching quick connects (available through Manitowoc Distributors K00129) be installed in the multi-circuit condenser, and that a vapor “holding” charge, 5 oz. (150 ml), of proper refrigerant be added to the condenser prior to connection of the ice machine or line set to the condenser.

Section 3 Operation



Touch Screen Features

The Indigo® control panel offers a series of pressure-sensitive buttons and an interactive touchscreen.

Buttons

Power Button: Provides On/Off functions for the ice machine.

Lock/Unlock Button: Allows or prevents touchscreen navigation.

Cleaning Button: Initiates a cleaning cycle. Refer to Section 4 for details.









Touchscreen

Home screen allows viewing of ice machine status, alerts and messages. Navigation with the touchscreen provides access to menu items, machine information, settings and event logs. Setup and Energy Saver settings can be adjusted along with access to service and troubleshooting information.

NOTE: Touchscreen is to be activated with finger tips only.

Icons: Provide status indication and allow navigation by pressing the icon.

HOME SCREEN ICON DESCRIPTIONS

Icon	Description
<p>Home Screen</p> 	<p>Center portion of the screen displays the current condition of the ice machine - Making ice, bin full, program mode or machine off</p>
<p>Alert</p> 	<p>Alert icon with number of messages. Pressing this icon will display the alert log which will allow viewing and resetting of alerts</p>
<p>Message</p> 	<p>Notification icon with quantity of messages. Pressing this icon will display the routine maintenance reminder screen which will allow viewing and resetting of the reminder</p>
<p>Menu</p> 	<p>Menu icon will take you to the main menu</p>
<p>Information</p> 	<p>Information icon provides model and serial number, installation date and other information specific to the ice machine</p>
<p>Service Locator</p> 	<p>Provides contact information for your local service support - Default is the Manitowoc Ice website service locator</p>
<p>Lock/Unlock</p> 	<p>Indicates if screen is locked or unlocked</p>
<p>LuminIce</p> 	<p>Only visible when a LuminIce II accessory is connected. Blue S - Normal operation Red S - Replace bulb Red/Blue alternating - Incorrect bulb installed</p>

Setup Wizard























Screens will automatically advance after a selection is made or press the right arrow to advance one screen, press left arrow to go back one screen. All settings can be accessed and changed without the wizard by using menu screen navigation.

Setup	Description
Press ON/OFF Button	On/Off button is used to start/stop ice making.
Enter Model Number	Only visible if model number can not be automatically identified. The ice machine will not start without model identification.
Select Language	Default is English. Scroll to select a different language.
Start Wizard	Setup wizard will guide ice machine programming.
Accessory Detection	Detects if Ice Level Sensor, LuminIce II or AuCS are connected. Checkmark = yes - X = no
USB Setup	Only used when setup features have been transferred to a USB drive. Skip screen by selecting right arrow.
Configure Date and Time Formats	Select Month/Day/Year or Day/Month/Year. Select 12 hour or 24 hour time format.
Set Time	Use arrows to set local time.
Set Date	Use arrows to set date for your location.
Units	Select standard or metric.
Brightness	Configure screen brightness during normal operation.

Setup	Description
Ice Program	Program ice machine run times or press right arrow to skip this setup.
Cleaning Reminder	Set clean or sanitize reminder or press right arrow to skip.
IAuCS Only when detected	Set frequency of operation when this accessory is installed.
Air Filter Air-cooled models only	Set to ON for self-contained air cooled models.
Water Usage	Factory default or Use less water for reverse osmosis systems or Use more water to improve clarity for unfiltered water
Water Filter	Select Yes or No.
LuminIce II Only when detected	12 month reminder is automatically set.
Ice Level Sensor Only when detected	Reminder to rotate the sensor from shipping to operational position.
Wizard Complete	Press right arrow or home icon to return to home screen.

Menu Screen Navigation

Select SETTINGS Icon from the Home Screen to access Main Menu screen.

Energy 	Service 	Settings 	Reset Defaults 
Ice Program 	Data 	Language 	Require Setup Wizard
Water Usage 	Alert Log 	Reminders 	Backup Current Settings
Statistics 	Manual Harvest 	Time & Date 	Reset To Factory Defaults
	Control Board Replacement 	Units 	
	Diagnostics 	Brightness 	
	Contact Information 	USB 	
	USB 	*AuCS 	
	*AuCS 		
	*Prime AuCS Pump 		

* Only visible when this optional accessory is installed

Ice Making Sequence of Operation

The power button must be depressed and the water curtain/ice dampers must be in place on the evaporator before the ice machine will start.

Water Purge Cycle

The ice machine purges any remaining water from the water trough down the drain.

Prechill Cycle

The refrigeration system cools the evaporator before the water pump is energized.

Freeze Cycle

Water flows across the evaporator and the refrigeration system chills the evaporator. Ice builds on the evaporator and the freeze cycle continues until the ice thickness probe senses a sheet of ice has formed. The ice thickness probe signals the control board to start a harvest.

Harvest Cycle

Any remaining water is purged down the drain as refrigerant gas warms the evaporator. When the evaporator warms, the sheet of cubes slides off the evaporator and into the storage bin. If all cubes fall clear of the water curtain (or ice damper) the ice machine starts another freeze cycle.

Off Cycle

If the water curtain or ice damper are held open by ice cubes the ice machine shuts off. When the water curtain or ice damper closes, the ice machine starts a new cycle at the water purge.

Control Board Timers

The control board has the following non-adjustable timers:

- The ice machine control board will set its own install date after 100 freeze and harvest cycles.
- The ice machine is locked into the freeze cycle for 6 minutes before a harvest cycle can be initiated.
- The maximum freeze time is 35 minutes at which time the control board automatically initiates a harvest sequence.
- The maximum harvest time is 7 minutes, the control board will perform a water thaw cycle and then return the ice machine to the freeze cycle.

Service Faults

Service Faults are stored and indicated by the control board after three cycles. The number of cycles required to stop the ice machine varies for each Service Fault.

- Long Freeze Cycle - If the freeze time reaches 35 minutes, the control board automatically initiates a harvest cycle. If 6 consecutive 35 minute freeze cycles occur, the ice machine stops.
- Long Harvest Cycle - If the harvest time reaches 7 minutes, the control board automatically returns the ice machine to the freeze cycle. After 3 consecutive long harvest cycles the ice machine stops.

Refer to Section 5 if you receive an alert for Service Fault E01 or E02.

Safe Operation Mode

Allows the ice machine to operate up to 72 hours if the ice thickness probe and/or water level probe sensors fail.

- When the control board starts the safe mode, an alert is flashed on the display to notify the end-user they have a production problem.
- The control board automatically initiates and monitors the safe mode. The control will automatically exit the safe mode if a normal signal is received from the input.
- After 72 hours, the control board will enter a standby mode and turn off.

NOTE: The control board needs a five cycle history to operate safe mode. If five cycles have never been successfully completed the ice machine will shut-off.

Water Assist Harvest

When the damper/curtain does not open within 3.5 minutes in the harvest cycle the following occurs:

- 3.5 minutes - The water inlet valve energizes until water touches the high water level probe.
- 4 minutes - The water pump energizes.
- 6.5 to 7 minutes - The water dump valve energizes.

Water Thaw Cycle

When the damper/curtain does not open during the 7 minute harvest cycle the following water thaw cycle occurs:

- 7 minutes - The compressor, harvest solenoid valve and dump valve de-energize.
 1. The water pump remains energized and the water inlet valve energizes until water touches the high water level probe.
 2. Water is circulated over the evaporator.
 3. Water is circulated, dumped and refilled to the high water level probe for approximately 1 hour.
- At the end of the thaw cycle the ice machine will start another freeze cycle (approximately 1 - 1.75 hour).

Minimum/Maximum Slab Weight

Adjust ice thickness to meet chart specifications.

Model	Minimum Ice Weight Per Cycle lbs Grams	Maximum Ice Weight Per Cycle lbs Grams
IF0300	2.40 lbs 1089 grams	2.80 lbs 1270 grams
IT0420 IT0450 IT0520 IT0620	3.40 lbs 1542 grams	3.90 lbs 1769 grams
IT0500	4.60 lbs 2087 grams	5.20 lbs 2359 grams
IF0600	4.12 lbs 1869 grams	4.75 lbs 2155 grams
IBF0820	5.75 lbs 2608 grams	6.50 lbs 2948 grams
IF0900	6.20 lbs 2812 grams	7.20 lbs 3266 grams
IT1200 IBF1020	7.50 lbs 3402 grams	8.20 lbs 3719 grams
IF1400 IT1500	10.25 lbs 4649 grams	11.50 lbs 5216 grams
IT1900	13.20 lbs 5987 grams	14.80 lbs 6713 grams
IF2100	15.50 lbs 7031 grams	16.75 lbs 7598 grams

Important

Routine adjustments and maintenance procedures are not covered by the warranty.

Ice Thickness Check

After a harvest cycle, inspect the ice cubes in the ice storage bin. The ice thickness probe is factory-set to maintain the ice bridge thickness at 1/8" (3 mm).

NOTE: Make sure the water curtain is in place when performing this check. It prevents water from splashing out of the water trough.

1. Inspect the bridge connecting the cubes. It must be approximately 1/8" (3 mm) thick.
2. If adjustment is necessary, turn the ice thickness probe adjustment screw clockwise to increase bridge thickness, counterclockwise to decrease bridge thickness. Set a 7 mm (9/32") gap between ice thickness probe and evaporator as starting point, then adjust to achieve a 1/8" (3 mm) bridge thickness.

NOTE: Turning the adjustment one-third of a turn will change the ice thickness about 1/16" (1.5 mm).

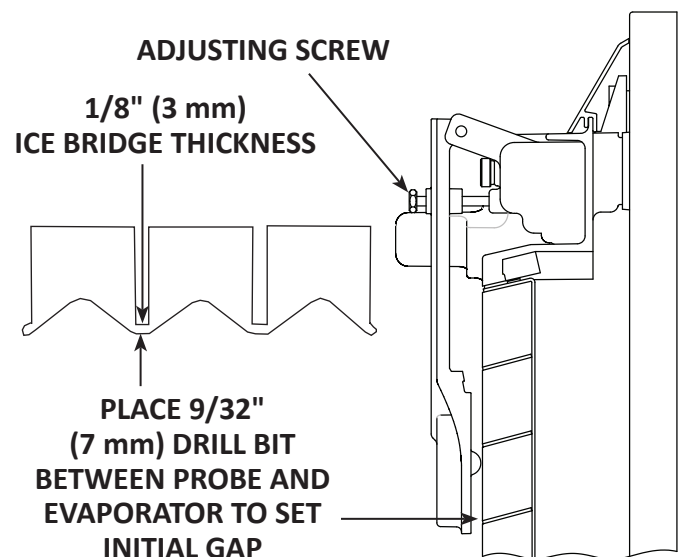

Verify the ice thickness probe wire doesn't restrict probe movement.

THIS PAGE INTENTIONALLY LEFT BLANK

Section 4 Maintenance

Cleaning and Sanitizing

General

You are responsible for maintaining the ice machine in accordance with the instructions in this manual. Maintenance procedures are not covered by the warranty.

Clean and sanitize the ice machine every six months for efficient operation. If the ice machine requires more frequent cleaning and sanitizing, consult a qualified service company to test the water quality and recommend appropriate water treatment. An extremely dirty ice machine must be taken apart for cleaning and sanitizing.

Manitowoc Ice Machine Cleaner and Sanitizer are the only products approved for use in Manitowoc ice machines.

Caution

Use only Manitowoc approved Ice Machine Cleaner and Sanitizer for this application (Manitowoc Cleaner part number 9405463 and Manitowoc Sanitizer part number 9405653). It is a violation of Federal law to use these solutions in a manner inconsistent with their labeling. Read and understand all labels printed on bottles before use.

Caution

Do not mix Cleaner and Sanitizer solutions together. It is a violation of Federal law to use these solutions in a manner inconsistent with their labeling.

Warning

Wear rubber gloves and safety goggles (and/or face shield) when handling Ice Machine Cleaner or Sanitizer.

Cleaning/Sanitizing Procedure

This procedure must be performed a minimum of once every six months.

- The ice machine and bin must be disassembled cleaned and sanitized.
- All ice produced during the cleaning and sanitizing procedures must be discarded.
- Removes mineral deposits from areas or surfaces that are in direct contact with water.

Preventative Maintenance Cleaning Procedure

- This procedure cleans all components in the water flow path, and is used to clean the ice machine between the bi-yearly cleaning/sanitizing procedure.

Exterior Cleaning

Clean the area around the ice machine as often as necessary to maintain cleanliness and efficient operation.

Wipe surfaces with a damp cloth rinsed in water to remove dust and dirt from the outside of the ice machine. If a greasy residue persists, use a damp cloth rinsed in a mild dish soap and water solution. Wipe dry with a clean, soft cloth.

The exterior panels have a clear coating that is stain resistant and easy to clean. Products containing abrasives will damage the coating and scratch the panels.

- Never use steel wool or abrasive pads for cleaning.
- Never use chlorinated, citrus based or abrasive cleaners on exterior panels and plastic trim pieces.

Cleaning/Sanitizing Procedure

⚠ Caution

Use only Manitowoc approved Ice Machine Cleaner and Sanitizer for this application (Manitowoc Cleaner part number 9405463 and Manitowoc Sanitizer part number 9405653). It is a violation of Federal law to use these solutions in a manner inconsistent with their labeling. Read and understand all labels printed on bottles before use.

CLEANING PROCEDURE

⚠ Caution

Do not mix Cleaner and Sanitizer solutions together. It is a violation of Federal law to use these solutions in a manner inconsistent with their labeling.

⚠ Warning

Wear rubber gloves and safety goggles (and/or face shield) when handling Ice Machine Cleaner or Sanitizer.

Ice machine cleaner is used to remove lime scale and mineral deposits. Ice machine sanitizer disinfects and removes algae and slime.

NOTE: Although not required and dependent on your installation, removing the ice machine top cover may allow easier access.

Step 1 Open the front door to access the evaporator compartment. Ice must not be on the evaporator during the clean/sanitize cycle. Follow one of the methods below:

- Press the power switch at the end of a harvest cycle after ice falls from the evaporator(s).
- Press the power switch and allow the ice to melt.

Notice

Never use anything to force ice from the evaporator. Damage may result.

Step 2 Remove all ice from the bin/dispenser.

Step 3 Press the Clean button and select “Turn off when complete”. Water will flow through the water dump valve and down the drain. Wait approximately 1 minute until the water trough refills and the display indicates Add Chemical. Add the proper amount of ice machine cleaner to the water trough by pouring between the water curtain and evaporator, then confirm the chemical was added.

Model	Amount of Cleaner
IF0300/IT0420/IT0620	3 oz (90 ml)
IT0450/IT0500/IF0600 IF0900/IT1200	5 oz (150 ml)
IBF0620C/IBF0820C IBT1020C	5 oz (150 ml)
IF1400C/IT1500/IF1800C IT1900/IF2100C	9 oz (265 ml)

Step 4 Wait until the clean cycle is complete (approximately *24 minutes). Then disconnect power to the ice machine (and dispenser when used).

▲ Warning

Disconnect the electric power to the ice machine at the electric service switch box.

Step 5 Remove parts for cleaning.

Refer to parts removal page 43. Continue with Step 6 when the parts have been removed.

Step 6 Mix a solution of cleaner and lukewarm water. Depending upon the amount of mineral buildup, a larger quantity of solution may be required. Use the ratio in the table below to mix enough solution to thoroughly clean all parts.

Solution Type	Water	Mixed With
Cleaner	1 gal (4 L)	16 oz (475 ml) cleaner

Step 7 Use half of the cleaner/water mixture to clean all components. The cleaner solution will foam when it contacts lime scale and mineral deposits; once the foaming stops, use a soft-bristle nylon brush, sponge or cloth (NOT a wire brush) to carefully clean the parts. Soak parts for 5 minutes (15 - 20 minutes for heavily scaled parts). Rinse all components with clean water.

Step 8 While components are soaking, use half of the cleaner/water solution to clean all food zone surfaces of the ice machine and bin (or dispenser). Use a nylon brush or cloth to thoroughly clean the following ice machine areas:

- Side walls
- Base (area above water trough)
- Evaporator plastic parts - including top, bottom and sides
- Bin or dispenser

Rinse all areas thoroughly with clean water.

SANITIZING PROCEDURE

Step 9 Mix a solution of sanitizer and lukewarm water.

Solution Type	Water	Mixed With
Sanitizer	3 gal (12 L)	2 oz (60 ml) sanitizer

Step 10 Use half of the sanitizer/water solution to sanitize all removed components. Use a spray bottle to liberally apply the solution to all surfaces of the removed parts or soak the removed parts in the sanitizer/water solution. Do not rinse parts after sanitizing.

Step 11 Use half of the sanitizer/water solution to sanitize all food zone surfaces of the ice machine and bin (or dispenser). Use a spray bottle to liberally apply the solution. When sanitizing, pay particular attention to the following areas:

- Side walls
- Base (area above water trough)
- Evaporator plastic parts - including top, bottom and sides
- Bin or dispenser

Do not rinse the sanitized areas.

Step 12 Replace all removed components and wait 20 minutes.

Step 13 Press the Clean button and select “Make ice when complete”. Water will flow through the water dump valve and down the drain. Wait approximately 1 minute until the water trough refills and the display indicates Add Chemical. Add the proper amount of ice machine sanitizer to the water trough by pouring between the water curtain and evaporator, then confirm the chemical was added.

Model	Amount of Sanitizer
IF0300/IT0420/IT0450 IT0500/IF0600/IT0620 IBF0620C/IBF0820C/IF0900	3 oz (90 ml)
IT1200/IBT1020C	3.5 oz (104 ml)
IT1500/IT1900	6 oz (180 ml)
IF1400C/IF1800C/IF2100C	12 oz (355 ml)

Step 14 Close and secure the front door. The ice machine will automatically start ice making after the sanitize cycle is complete (approximately 24 minutes).

Parts Removal for Cleaning/Sanitizing

Single evaporator is shown; Each evaporator will have a distribution tube and water curtain/damper.

A. Remove the water curtain(s)

- Gently flex the curtain in the center and remove it from the right side.
- Slide the left pin out.

B. Remove the ice thickness probe

- Compress the hinge pin on the top of the ice thickness probe.
- Pivot the ice thickness probe to disengage one pin then the other. The ice thickness probe can be cleaned at this point without complete removal. If complete removal is desired, disconnect the ice thickness control wiring from the control board.

C. Remove the water trough

- Depress tabs on right and left side of the water trough.
- Allow front of water trough to drop as you pull forward to disengage the rear pins.

D. Remove the water level probe

- Pull the water level probe straight down to disengage.
- Lower the water level probe until the wiring connector is visible.
- Disconnect the wire lead from the water level probe.
- Remove the water level probe from the ice machine.

E. Remove the water distribution tube(s)

NOTE: Thumbscrews for the distribution tube are retained to prevent loss. Loosen thumbscrews, but do not pull thumbscrews out of distribution tube.

- Loosen the two outer screws (do not remove screws completely because they are retained to prevent loss) and pull forward on the distribution tube to release from slip joint.
- Disassemble distribution tube by loosening the two (2) middle thumbscrews and dividing the distribution tube into two pieces.

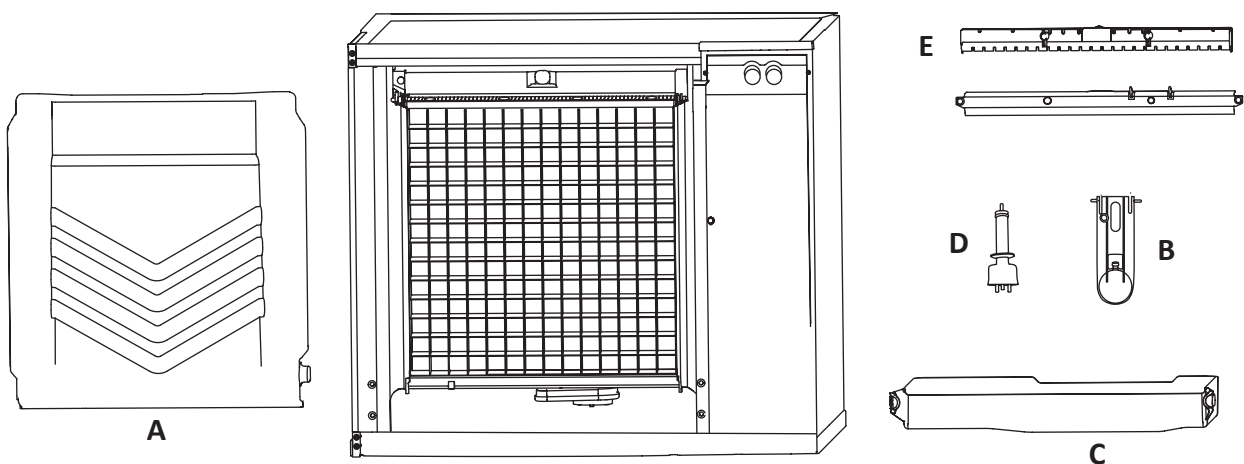

Preventative Maintenance Cleaning Procedure

This procedure cleans all components in the water flow path, and is used to clean the ice machine between the bi-yearly cleaning/sanitizing procedure.

Ice machine cleaner is used to remove lime scale and mineral deposits. Ice machine sanitizer disinfects and removes algae and slime.

NOTE: Although not required and dependent on your installation, removing the ice machine top cover may allow easier access.

Step 1 Ice must not be on the evaporator during the clean/sanitize cycle. Follow one of the methods below:

- Press the power switch at the end of a harvest cycle after ice falls from the evaporator(s).
- Press the power switch and allow the ice to melt.

Notice

Never use anything to force ice from the evaporator. Damage may result.

Step 2 Open the front door to access the evaporator.

Step 3 Press the Clean button and select “Make ice when complete”. Water will flow through the water dump valve and down the drain. Wait approximately 1 minute until the water trough refills and the display indicates Add Chemical. Add the proper amount of ice machine cleaner to the water trough by pouring between the water curtain and evaporator, then confirm the chemical was added.

Model	Amount of Cleaner
IF0300/IT0420/IT0620	3 oz (90 ml)
IT0450/IT0500/IF0600 IF0900/IT1200	5 oz (150 ml)
IBF0620C/IBF0820C IBT1020C	5 oz (150 ml)
IF1400C/IT1500/IF1800C IT1900/IF2100C	9 oz (265 ml)

Step 4 Close and secure the front door. The ice machine will automatically start ice-making after the clean cycle is complete (approximately 24 minutes).

Cleaning the Air Filter and Condenser

The washable filter on self-contained ice machines is designed to catch dust, dirt, lint and grease. Clean the filter once a month with mild soap and water.

A dirty condenser restricts airflow, resulting in excessively high operating temperatures. This reduces ice production and shortens component life.

▲Warning

Disconnect electric power to the ice machine at the electric service switch before cleaning the air filter or the condenser. The condenser fins are sharp; Use care when removing or installing the air filter.

- Clean the condenser at least every six months.
- Shine a flashlight through the condenser to check for dirt between the fins.
- Blow compressed air or rinse with water from the inside out (opposite direction of airflow).
- If dirt still remains, call a service agent to clean the condenser.

Removal from Service/Winterization

All Models

1. Clean and sanitize the ice machine.
2. Turn off the water supply, disconnect and drain the incoming ice-making water line at the rear of the ice machine and drain the water trough.
3. Energize the ice machine, wait one minute for the water inlet valve to open and blow compressed air in both the incoming water and the drain openings in the rear of the ice machine to remove all water.

WATER-COOLED MODELS ONLY

- Disconnect the incoming water and drain lines from the water-cooled condenser.
- Insert a large screwdriver between the bottom spring coils of the water regulating valve and pry open the Water Regulating Valve.
- Hold the valve open and blow compressed air through the condenser until no water remains.

All Models

4. Press the power switch and disconnect electrical power at the main disconnect/circuit breaker.
5. Fill spray bottle with sanitizer and spray all interior food zone surfaces. Do not rinse and allow to air dry.
6. Replace all panels.

THIS PAGE INTENTIONALLY LEFT BLANK

Section 5 Troubleshooting

Before Calling for Service Checklist

If a problem arises during operation of your ice machine, follow the checklist below before calling service. Routine adjustments and maintenance procedures are not covered by the warranty.

Problem	Possible Cause	To Correct
Ice machine does not operate.	No electrical power to the ice machine and/or condensing unit.	Replace the fuse/reset the breaker/turn on the main switch.
	High pressure cutout tripping.	Clean condenser coil. (See page 45)
	Energy Saver or other field entered programming is stopping ice machine.	Reset to factory defaults.
	Water curtain off or stuck open.	Water curtain must be installed and swinging freely.
	Ice machine is not turned on.	Press power button, display must indicate "Making Ice".
	IB Models Only - Dispenser ice level thermostat is open.	Adjust thermostat to maintain correct dispenser level.
Ice machine stops, and can be restarted by pressing the power switch.	Service Fault feature stopping the ice machine.	Refer to "Service Faults" on page 49.
Ice machine does not release ice or is slow to harvest.	Ice machine is dirty.	Clean and sanitize the ice machine. (See page 40)
	Ice machine is not level.	Level the ice machine.
	Low air temperature around ice machine head section.	Air temperature must be at least 35° (2°C).
	Fan cycle control does not de-energize condenser fan motor.	Call for service.
	Water regulating valve incorrectly adjusted or will not close.	Check for water at condenser drain outlet in harvest cycle. Contact a qualified service company to adjust/replace valve if water is present.

Problem	Possible Cause	To Correct
Ice machine does not cycle into harvest mode.	The six-minute freeze time lock-in has not expired yet.	Wait for the freeze lock-in to expire.
	Ice thickness probe is dirty.	Clean and sanitize the ice machine. (See page 40)
	Ice thickness probe is disconnected.	Connect the probe to the control board.
	Ice thickness probe is out of adjustment.	Adjust the ice thickness probe. (See page 37)
	Uneven ice fill (thin at the top of evaporator).	Verify sufficient water level in sump trough. Contact a qualified service company to check refrigeration system.
Ice quality is poor (soft or not clear).	Poor incoming water quality.	Contact a qualified service company to test the quality of the incoming water and make appropriate filter recommendations.
	Water filtration is poor.	Replace the filter.
	Ice machine is dirty.	Clean and sanitize the ice machine. (See page 40)
	Water dump valve is not working.	Disassemble and clean the water dump valve.
	Water softener is working improperly (if applicable).	Repair the water softener.
Ice machine produces shallow or incomplete cubes, or the ice fill pattern on the evaporator is incomplete.	Ice thickness probe is out of adjustment.	Adjust the ice thickness probe. (See page 37)
	Water trough level is too low.	Check the water level probe position.
	Water inlet valve filter screen is dirty.	Remove the water inlet valve and clean the filter screen.
	Water filtration is poor.	Replace the filter.
	Hot incoming water.	Connect the ice machine to a cold water supply. (See page 19)
	Water inlet valve is not working.	Replace the water inlet valve.
	Incorrect incoming water pressure.	Water pressure must be 20 psi - 80 psi (140 kPa - 550 kPa).
	Ice machine is not level.	Level the ice machine.

Problem	Possible Cause	To Correct
Low ice capacity.	Water inlet valve filter screen is dirty.	Remove the water inlet valve and clean the filter screen.
	Incoming water supply is shut off.	Open the water service valve.
	Water inlet valve stuck open or leaking.	Press the power button and turn off the ice machine, if water continues to enter water trough, replace the water inlet valve.
	The condenser is dirty.	Clean the condenser.
	High air temperature entering condenser.	Refer to air temperature chart for your model on page 12.
	The harvest assist air compressor is not functioning.	Call for service.

Service Faults

In addition to the standard safety controls, such as the high pressure cutout, your Manitowoc ice machine features built-in service faults which will stop the ice machine if conditions arise which could cause a major component failure.

Before calling for service, re-start the ice machine using the following procedure:

1. Press the power button. The display reads "Off". Press the power button again, and the display reads "Making Ice".
 - A. If a service fault has stopped the ice machine, it will restart after a short delay. Proceed to step 2.
 - B. If the ice machine does not restart, see "Ice machine does not operate" on page 47.
2. Allow the ice machine to run to determine if the condition repeats.
 - A. If the ice machine stops again, the condition has repeated. Call for service.
 - B. If the ice machine continues to run, the condition has corrected itself. Allow the ice machine to continue running.

THIS PAGE INTENTIONALLY LEFT BLANK



MANITOWOC ICE
ICE MACHINE DIVISION
2110 SOUTH 26TH STREET
MANITOWOC, WI 54220

800-545-5720
WWW.MANITOWOCICE.COM



WWW.WELBILT.COM

Welbilt provides the world's top chefs, and premier chain operators or growing independents with industry leading equipment and solutions. Our cutting-edge designs and lean manufacturing tactics are powered by deep knowledge, operator insights, and culinary expertise.

All of our products are backed by KitchenCare® – our aftermarket, repair, and parts service.

- | | | | |
|---------------|---------------|--------------|--------------|
| ▶ CLEVELAND | ▶ FITKITCHEN™ | ▶ KOLPAK® | ▶ MERCO® |
| ▶ CONVOTHERM® | ▶ FRYMASTER® | ▶ LINCOLN | ▶ MERRYCHEF® |
| ▶ DELFIELD® | ▶ GARLAND | ▶ MANITOWOC® | ▶ MULTIPLEX® |